

95092-95097 Series

High Temperature, High Voltage Flyback Transformer

The 95092-97 high temperature, high voltage flyback transformers are designed especially for high voltage boost converter applications where it is necessary to supply a high output voltage and current to quickly charge a high voltage storage capacitor in an elevated temperature environment. The monolithic ceramic transformers are available in a leadless package with side terminations. Operating temperature ranges from -55° to 250°C. The 'STX' versions provide additional thermal cycling and testing for each part based on MIL-STD 202 Method 107. Specifications for this device include applications notes, with specific performance parameters.

Features

- 1:8 turns ratio
- Low profile < 2.5 mm
- Low Volume < 230 cu mm
- Light weight 1.1gm
- Surface mount with side terminations
- Switching frequency to 300kHz
- Can charge 120 nF to 1000V in <40ms.

Applications

High voltage boost converters

Ordering Information

Part Number	Temp. Range
95092	-55 to 250°C
95093	-55 to 225°C
95094	-55 to 200°C
95095	-55 to 175°C
95096	-55 to 150°C
95097	-55 to 125°C

For Burn-In add suffix

	Temp. Range
-STXB	-65 to 125°C
-STXF	-65 to 150°C
-STXC	-65 to 200°C

Lead Configuration (bottom/side view)

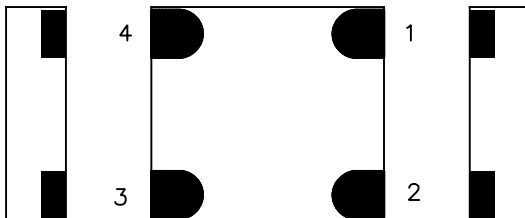

Schematic

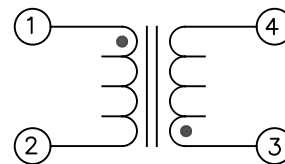

Absolute Maximum Ratings

Volt-Time Product: 100 V-us
 Storage Temperature: -65 to 300°C
 Dielectric Rating: 1500 VAC, 1s

Operating Ratings

Volt-Time Product: 90 V-us
 Operating Temperature: -55 to 250°C
 Thermal Resistance: 110°C/W

NOTE: Specifications subject to change without notice.

D50 B99

NASCENTechnology Manufacturing Inc. 1404 9th Ave SW Watertown, SD 57201 USA	Unless otherwise specified: Tolerances: Fractions: ±1/64 Angles: ±1° Decimals: ±.005[.13]		NASCENTechnology	DWG.# 95092-97
	DRAWING TITLE <h2 style="margin: 0;">TRANSFORMER</h2>			
This drawing is dual dimensioned. Dimensions in brackets are in millimeters.	REVISIONS: SEE SHEET 1		SCALE ---	SHEET 1 OF 6

95092-95097 Series

High Temperature, High Voltage Flyback Transformer

ELECTRICAL SPECIFICATIONS

At 25°C unless otherwise noted.

Parameter	Condition	Min	Typ	Max	Units
DC Resistance	(1-2)	1.44	1.70	1.96	ohms
	(3-4)	36.5	43.0	49.5	ohms
Inductance	100 kHz, 0.5 VAC, 0 ADC, Ls (1-2)	28.0	35.0	43.8	uH
	(3-4)	1.04	1.38	1.73	mH
Pulse Inductance	15 VDC, 2.0 Apk		50.0		uH
Leakage Inductance	100 kHz, 0.5 VAC, 0 ADC, Ls (1-2), tie 3+4		16.0		uH
Q (Quality Factor)	100 kHz, 0.5 VAC, 0 ADC, Ls (1-2)		10		
Turns Ratio	(1-2) : (3-4)		1:8		
Dielectric Rating	1500 VAC, 60 Hz applied for 1s			1500	Volts
Insulation Resistance	100 VDC, 5s	1000			Mohms

TYPICAL CIRCUIT PERFORMANCE SPECIFICATIONS

(T=25°C, Vs=15 VDC, Cout=30 nF)

Peak input current		1.4	1.5	1.6	A
Output Voltage (minimum)		1300	1400	1500	VDC
Peak Input Current (Vs=15 VDC, using R1015 demo board)			1.1	2.0	A
Charge Times (typical) 120 nF Capacitor	to 1000 V		50	20	ms
	to 1250 V			40	ms
	to 1500 V			90	ms

SCREEN TEST ELECTRICAL LIMITS (STX)

(Vs=15 VDC, Load=100 Mohm+30 nF, Period: 20 us, Pulse width ~4.0 us)

Peak input Current		1.50	A
Minimum Output Voltage at 25°C (±2°C)		1400	Vpeak

NOTE: Specifications subject to change without notice.

 NASCENT Technology		DWG.# 95092-97
DRAWING NO.	REV.	
95092-97	6C 5/17	
SCALE ---	SHEET 2 OF 6	

95092-95097 Series

High Temperature, High Voltage Flyback Transformer

Output Characteristics

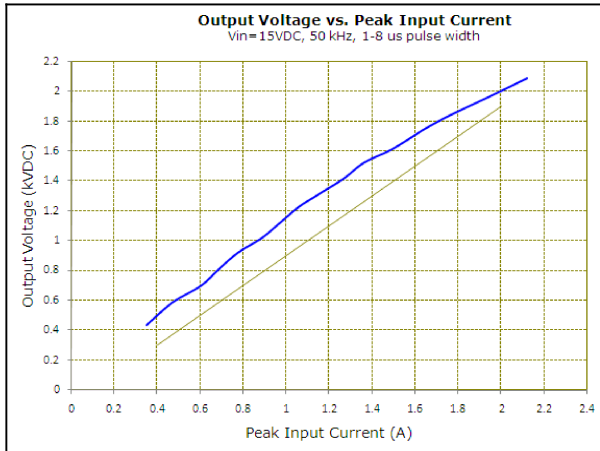

Chart 1. Output Voltage vs. Peak Input Current

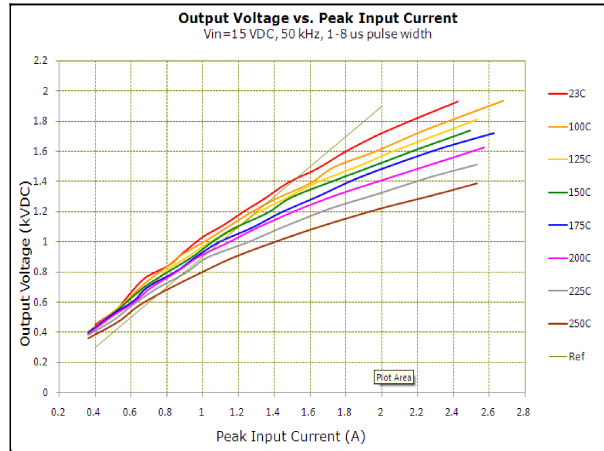

Chart 2. Output Voltage vs. Peak Input Current

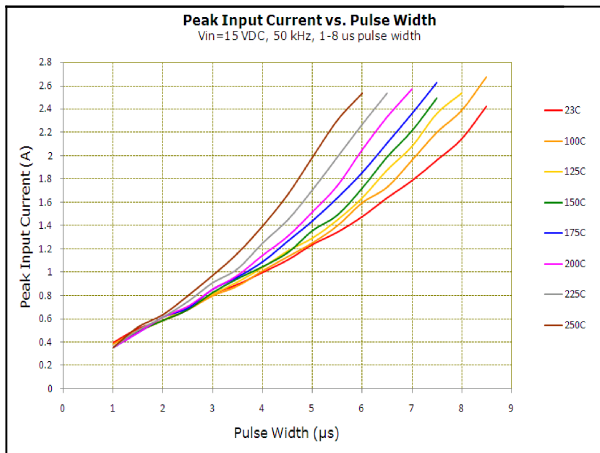

Chart 3. Peak Input Current vs. Pulse Width

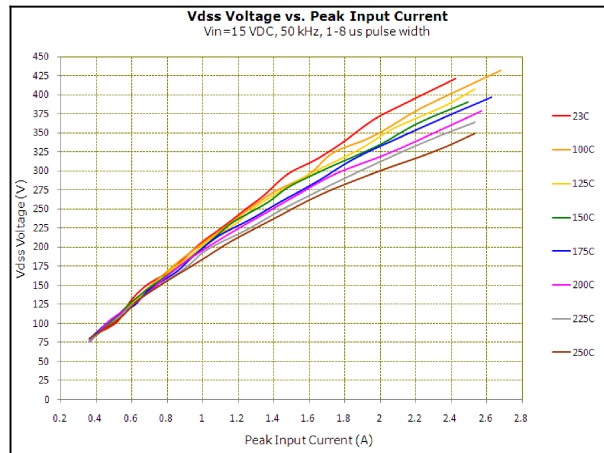

Chart 4. Vdss vs. Peak Input Current

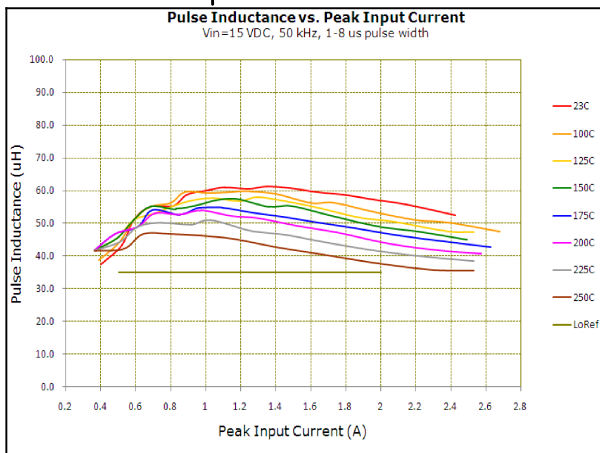

Chart 5. Pulse Inductance vs. Peak Input Current

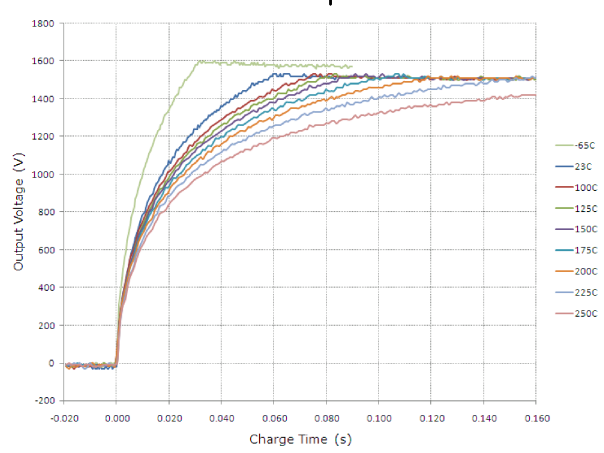

Chart 6. Charge Time at Various Temperatures
R1039 Demo Board, Vin=15VDC, Ipk=2.7A, 120nF
Regulation set to 1500V.

NOTE: Tests above room temperature are made with 6 inch leads which degrades output by approximately 100V.

NOTE: Specifications subject to change without notice.



DRAWING NO.

95092-97

REV.

6C
5/17

SCALE ---

SHEET 3 OF 6

DWG.# 95092-97

95092-95097 Series STX

High Temperature, High Voltage Flyback Transformer

Environmental Stress Screening Burn-In

Screening Procedure

- 1) All units are serialized.
- 2) Measure and record inductance for each unit at room temperature. (100 kHz, 0.5 Vac, 0 ADC, Ls)
- 3) Units subjected to ten cycles, per MIL-STD 202, Method 107, and one of the following:
 - Condition B (-65 to +125C)
 - Condition F (-65 to +150C)
 - Condition C (-65 to +200C)15 minute soak, 5 minute transition time.
- 4) Measure and record inductance for each unit. Must be <10% change from pre-stress values.
All units outside of the specification are discarded from the lot.
- 5) Measure and record output voltage each unit at room temperature. Must meet minimum specification.
All units outside of the specification are discarded from the lot.

Test circuit

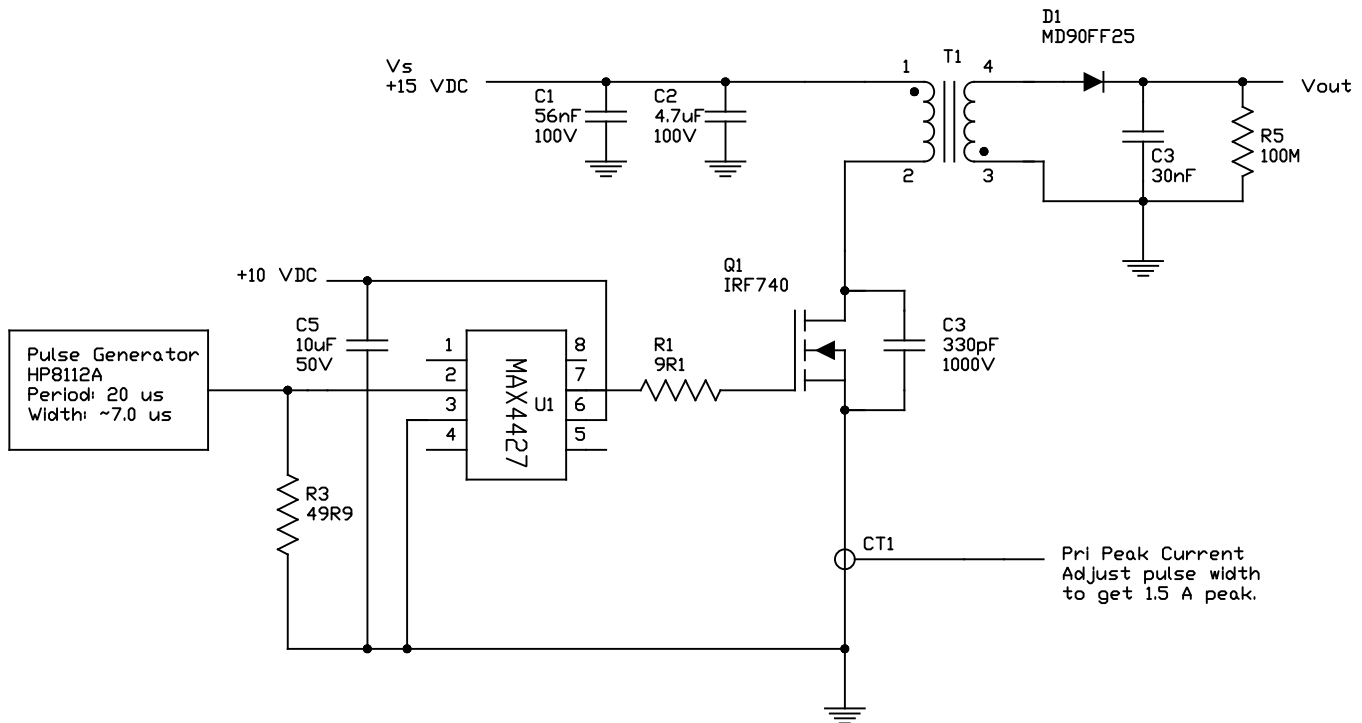

Note: Specifications subject to change without notice.



DRAWING NO.

95092-97

REV.

6C
5/17

SCALE ---

SHEET 4 OF 6

DWG.#
95092-97

95092-95097 Series

High Temperature, High Voltage Flyback Transformer

Application circuit

Fast, high voltage generator for a high current pulse generator.

The 95092 transformer circuit below is designed to quickly charge a high voltage capacitor to 1200 volts so that it may provide a high current pulse to a low resistance load. The circuit has a peak current of 2.0 A. The primary current is commutated by Q1, and will produce a secondary boost voltage of 1200V. The output is regulated via a voltage divider feedback resistor to the MAX1771 controller.

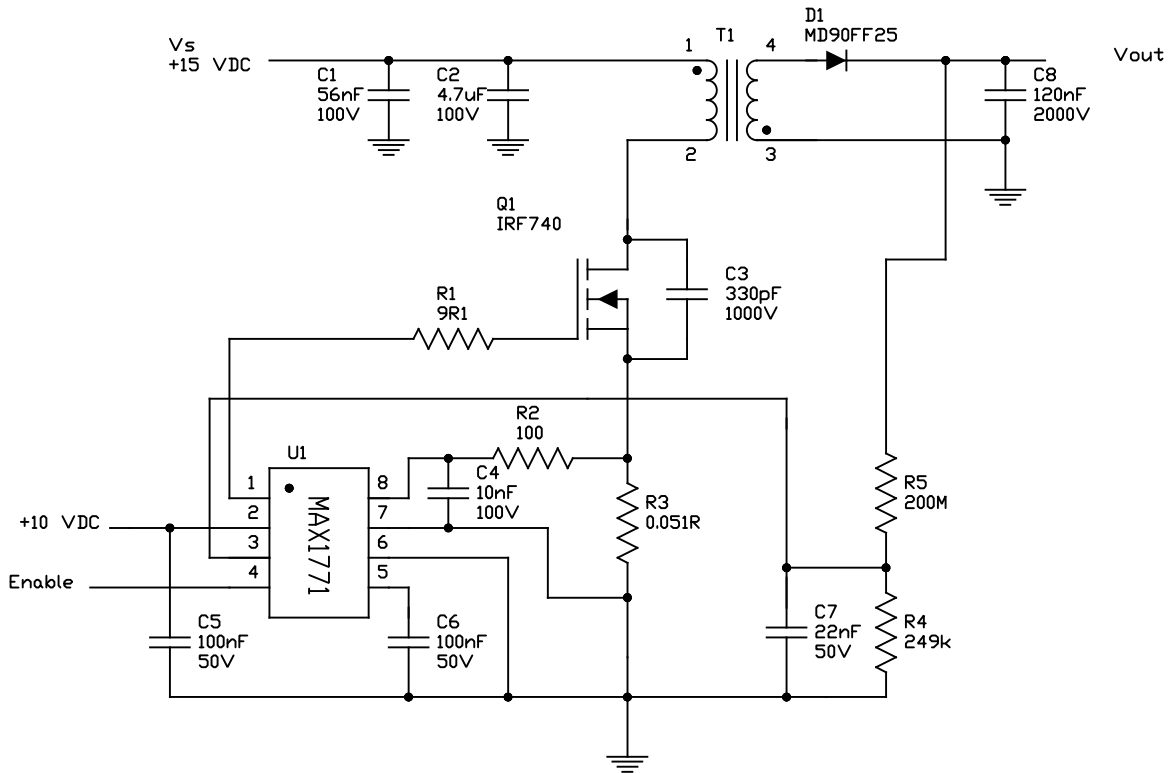

NOTE: Specifications subject to change without notice.

 **NASCENT**Technology

DRAWING NO.

95092-97

REV.

6C
5/17

SCALE ---

SHEET 5 OF 6

DWG.# 95092-97

95092-95097 Series

High Temperature, High Voltage Flyback Transformer

Package Dimensions

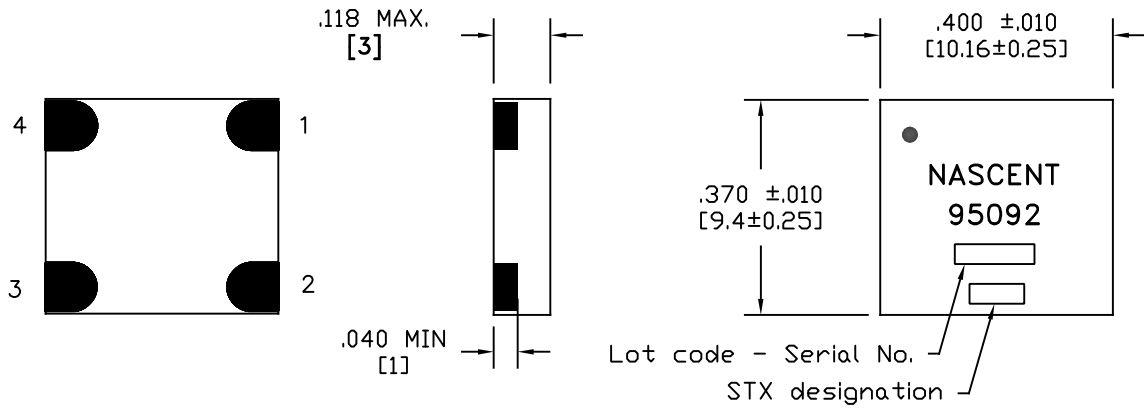

Terminals are Silver/Platinum alloy.

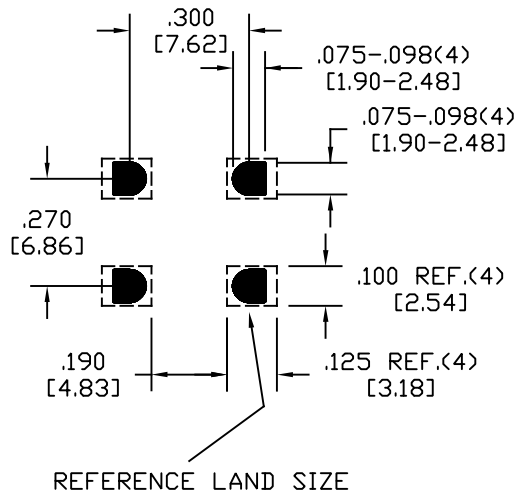
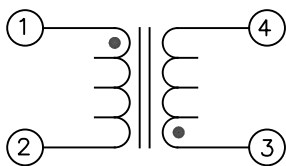

NOTE: Severe temperature and mechanical applications may require underfill.

NOTE: Specifications subject to change without notice.

 NASCENT Technology		DWG.# 95092-97
SCALE ---	SHEET 6 OF 6	